

Description

The P4SMA-Q series is designed specifically to protect sensitive electronic equipment from voltage transients induced by lightning and other transient voltage events. For surface mounted applications in order to optimize board space.

Features

- Halogen free and RoHS compliant
- Low profile package
- Built-in strain relief design
- Low inductance
- Excellent clamping capability
- 400W peak pulse power capability at 10/1000 μ s waveform, repetition rate (duty cycle): 0.01%
- Fast response time
- Typical I_R less than 1 μ A above 12V devices
- Peak 260 $^{\circ}$ C high temperature Reflow Soldering withstanding
- Meet MSL level1, per J-STD-020
- IEC-61000-4-2 ESD 30kV(Air), 30kV (Contact)
- Unit Weight: 0.07g
- AEC-Q101 Qualified

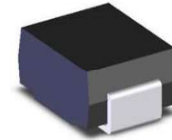

Applications

TVS components are ideal for the protection of I/O Interfaces, VCC bus and other vulnerable circuits used in telecom, computer, Industrial and consumer electronic applications.

Maximum Ratings and Characteristics ($T_A=25^{\circ}\text{C}$)

Rating	Symbol	Value
Peak pulse power dissipation at 10/1000 μ s waveform (Note1, Note2, Fig.1)	P_{PPM}	400W
Peak pulse current of at 10/1000 μ s waveform (Note 1, Fig.3)	I_{PPM}	See Table(A)
Steady state power dissipation at $T_A=50^{\circ}\text{C}$ (Fig.5)	$P_{M(AV)}$	3.3W
Maximum Instantaneous Forward Voltage at 25A for Unidirectional Only	V_F	3.5V/5.0V
Peak forward surge current, 8.3ms single half sine-wave superimposed on rated load, (JEDEC Method) (Note3, Fig.6)	I_{FSM}	60A
Operating junction and Storage Temperature Ranges	T_J, T_{STG}	-55 $^{\circ}\text{C}$ to +150 $^{\circ}\text{C}$
Typical thermal resistance junction to lead	$R_{\theta JL}$	30 $^{\circ}\text{C}/\text{W}$
Typical thermal resistance junction to ambient	$R_{\theta JA}$	120 $^{\circ}\text{C}/\text{W}$

Notes:1. Non-repetitive current pulse, per Fig.3 and derating above $T_A=25^{\circ}\text{C}$ per Fig.2.

2. Each terminal is surface Mounted on the 5.0mm \times 5.0mm (0.03mm thick) copper pads.

3. 8.3ms single half sine-wave or equivalent square wave, duty cycle=4 pulses per minutes maximum.

4. $V_F<3.5\text{V}$ for single die parts and $V_F<5.0\text{V}$ for stacked-die parts.

Electrical Characteristics (T_A=25°C)

Part Number		Device Marking Code		Reverse Stand-Off Voltage	Breakdown Voltage @I _T		Test Current	Maximum Clamping Voltage @I _{PP}	Peak Pulse Current	Reverse Leakage @V _R
Uni.	Bi.	Uni.	Bi.	V _R (V)	V _{B Min.} (V)	V _{B Max.} (V)	I _T (mA)	V _C (V)	I _{PP} (A)	I _R (μA)
P4SMA6.8A-Q	P4SMA6.8CA-Q	6V8A	6V8C	5.80	6.45	7.14	10	10.5	39.0	1000
P4SMA7.5A-Q	P4SMA7.5CA-Q	7V5A	7V5C	6.40	7.13	7.88	10	11.3	36.3	500
P4SMA8.2A-Q	P4SMA8.2CA-Q	8V2A	8V2C	7.02	7.79	8.61	10	12.1	33.9	200
P4SMA9.1A-Q	P4SMA9.1CA-Q	9V1A	9V1C	7.78	8.65	9.55	1	13.4	30.6	50
P4SMA10A-Q	P4SMA10CA-Q	10A	10C	8.55	9.50	10.50	1	14.5	28.3	10
P4SMA11A-Q	P4SMA11CA-Q	11A	11C	9.40	10.50	11.60	1	15.6	26.3	5
P4SMA12A-Q	P4SMA12CA-Q	12A	12C	10.20	11.40	12.60	1	16.7	24.6	5
P4SMA13A-Q	P4SMA13CA-Q	13A	13C	11.10	12.40	13.70	1	18.2	22.5	1
P4SMA15A-Q	P4SMA15CA-Q	15A	15C	12.80	14.30	15.80	1	21.2	19.3	1
P4SMA16A-Q	P4SMA16CA-Q	16A	16C	13.60	15.20	16.80	1	22.5	18.2	1
P4SMA18A-Q	P4SMA18CA-Q	18A	18C	15.30	17.10	18.90	1	25.2	16.1	1
P4SMA20A-Q	P4SMA20CA-Q	20A	20C	17.10	19.00	21.00	1	27.7	14.8	1
P4SMA22A-Q	P4SMA22CA-Q	22A	22C	18.80	20.90	23.10	1	30.6	13.4	1
P4SMA24A-Q	P4SMA24CA-Q	24A	24C	20.50	22.80	25.20	1	33.2	12.3	1
P4SMA27A-Q	P4SMA27CA-Q	27A	27C	23.10	25.70	28.40	1	37.5	10.9	1
P4SMA30A-Q	P4SMA30CA-Q	30A	30C	25.60	28.50	31.50	1	41.4	9.9	1
P4SMA33A-Q	P4SMA33CA-Q	33A	33C	28.20	31.40	34.70	1	45.7	9.0	1
P4SMA36A-Q	P4SMA36CA-Q	36A	36C	30.80	34.20	37.80	1	49.9	8.2	1
P4SMA39A-Q	P4SMA39CA-Q	39A	39C	33.30	37.10	41.00	1	53.9	7.6	1
P4SMA43A-Q	P4SMA43CA-Q	43A	43C	36.80	40.90	45.20	1	59.3	6.9	1
P4SMA47A-Q	P4SMA47CA-Q	47A	47C	40.20	44.70	49.40	1	64.8	6.3	1
P4SMA51A-Q	P4SMA51CA-Q	51A	51C	43.60	48.50	53.60	1	70.1	5.8	1
P4SMA56A-Q	P4SMA56CA-Q	56A	56C	47.80	53.20	58.80	1	77.0	5.3	1
P4SMA62A-Q	P4SMA62CA-Q	62A	62C	53.00	58.90	65.10	1	85.0	4.8	1
P4SMA68A-Q	P4SMA68CA-Q	68A	68C	58.10	64.60	71.40	1	92.0	4.5	1

Electrical Characteristics (T_A=25°C)

Part Number		Device Marking Code		Reverse Stand-Off Voltage	Breakdown Voltage @I _T		Test Current	Maximum Clamping Voltage @I _{PP}	Peak Pulse Current	Reverse Leakage @V _R
Uni.	Bi.	Uni.	Bi.	V _R (V)	V _{B Min.} (V)	V _{B Max.} (V)	I _T (mA)	V _C (V)	I _{PP} (A)	I _R (μA)
P4SMA75A-Q	P4SMA75CA-Q	75A	75C	64.10	71.30	78.80	1	103.0	4.0	1
P4SMA82A-Q	P4SMA82CA-Q	82A	82C	70.10	77.90	86.10	1	113.0	3.6	1
P4SMA91A-Q	P4SMA91CA-Q	91A	91C	77.80	86.50	95.50	1	125.0	3.3	1
P4SMA100A-Q	P4SMA100CA-Q	100A	100C	85.50	95.00	105.0	1	137.0	3.0	1
P4SMA110A-Q	P4SMA110CA-Q	110A	110C	94.00	105.0	116.0	1	152.0	2.7	1
P4SMA120A-Q	P4SMA120CA-Q	120A	120C	102.00	114.0	126.0	1	165.0	2.5	1
P4SMA130A-Q	P4SMA130CA-Q	130A	130C	111.00	124.0	137.0	1	179.0	2.3	1
P4SMA150A-Q	P4SMA150CA-Q	150A	150C	128.00	143.0	158.0	1	207.0	2.0	1
P4SMA160A-Q	P4SMA160CA-Q	160A	160C	136.00	152.0	168.0	1	219.0	1.9	1
P4SMA170A-Q	P4SMA170CA-Q	170A	170C	145.00	162.0	179.0	1	234.0	1.8	1
P4SMA180A-Q	P4SMA180CA-Q	180A	180C	154.00	171.0	189.0	1	246.0	1.7	1
P4SMA200A-Q	P4SMA200CA-Q	200A	200C	171.00	190.0	210.0	1	274.0	1.5	1
P4SMA220A-Q	P4SMA220CA-Q	220A	220C	185.00	209.0	231.0	1	328.0	1.3	1
P4SMA250A-Q	P4SMA250CA-Q	250A	250C	214.00	237.0	263.0	1	344.0	1.2	1
P4SMA300A-Q	P4SMA300CA-Q	300A	300C	256.00	285.0	315.0	1	414.0	1.0	1
P4SMA350A-Q	P4SMA350CA-Q	350A	350C	300.00	332.0	368.0	1	482.0	0.9	1
P4SMA400A-Q	P4SMA400CA-Q	400A	400C	342.00	380.0	420.0	1	548.0	0.8	1
P4SMA440A-Q	P4SMA440CA-Q	440A	440C	376.00	418.0	462.0	1	602.0	0.7	1
P4SMA480A-Q	P4SMA480CA-Q	480A	480C	408.00	456.0	504.0	1	658.0	0.6	1
P4SMA510A-Q	P4SMA510CA-Q	510A	510C	434.00	485.0	535.0	1	698.0	0.6	1
P4SMA530A-Q	P4SMA530CA-Q	530A	530C	450.00	503.5	556.5	1	725.0	0.6	1
P4SMA540A-Q	P4SMA540CA-Q	540A	540C	459.00	513.0	567.0	1	740.0	0.5	1
P4SMA550A-Q	P4SMA550CA-Q	550A	550C	467.00	522.5	577.5	1	760.0	0.5	1
P4SMA600A-Q	P4SMA600CA-Q	600A	600C	510.0	575.2	628.4	1	828.0	0.49	1

Ratings and Characteristic Curves ($T_A=25^\circ\text{C}$)

Figure 1. Peak Pulse Power Rating Curve

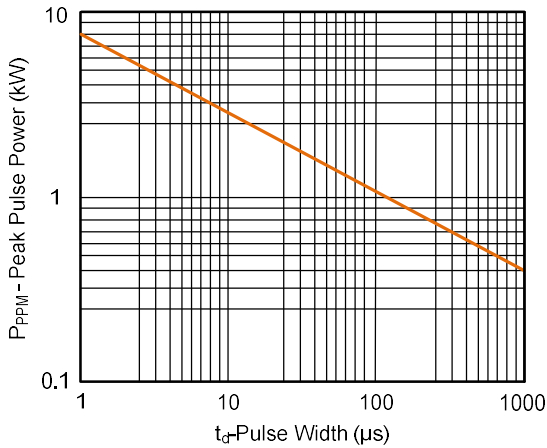

Figure 2. Pulse Derating Curve

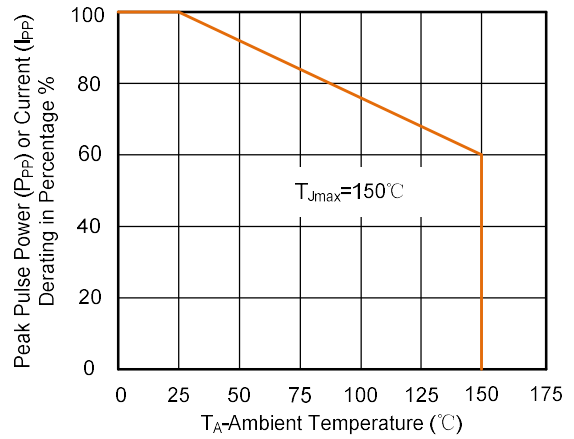

Figure 3. Pulse Waveform

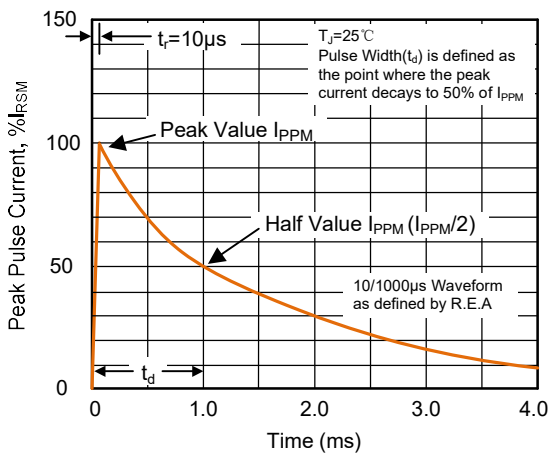

Figure 4. Typical Junction Capacitance

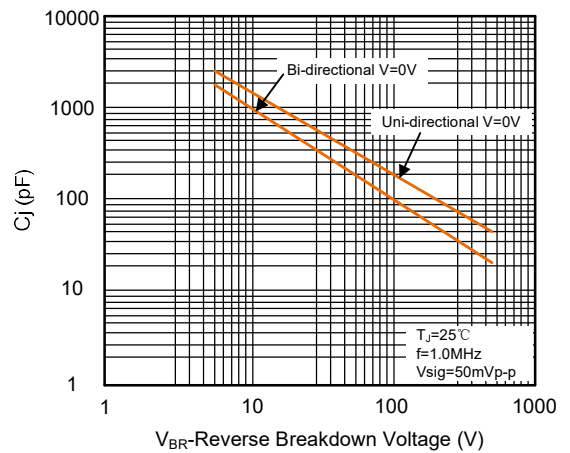

Figure 5. Steady State Power Dissipation Derating Curve

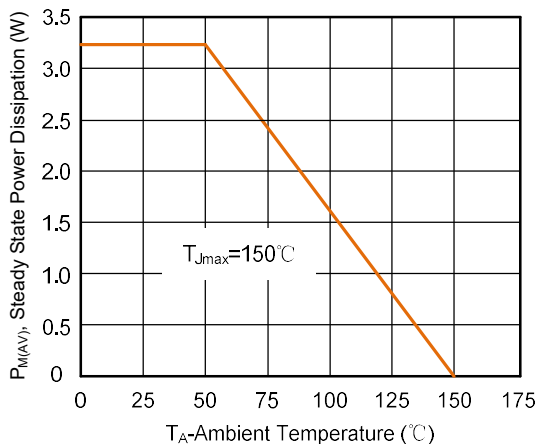
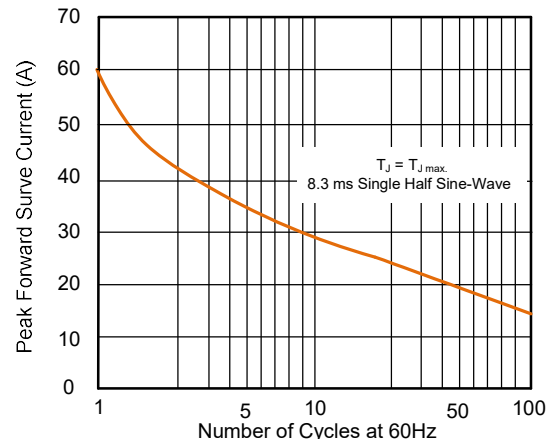
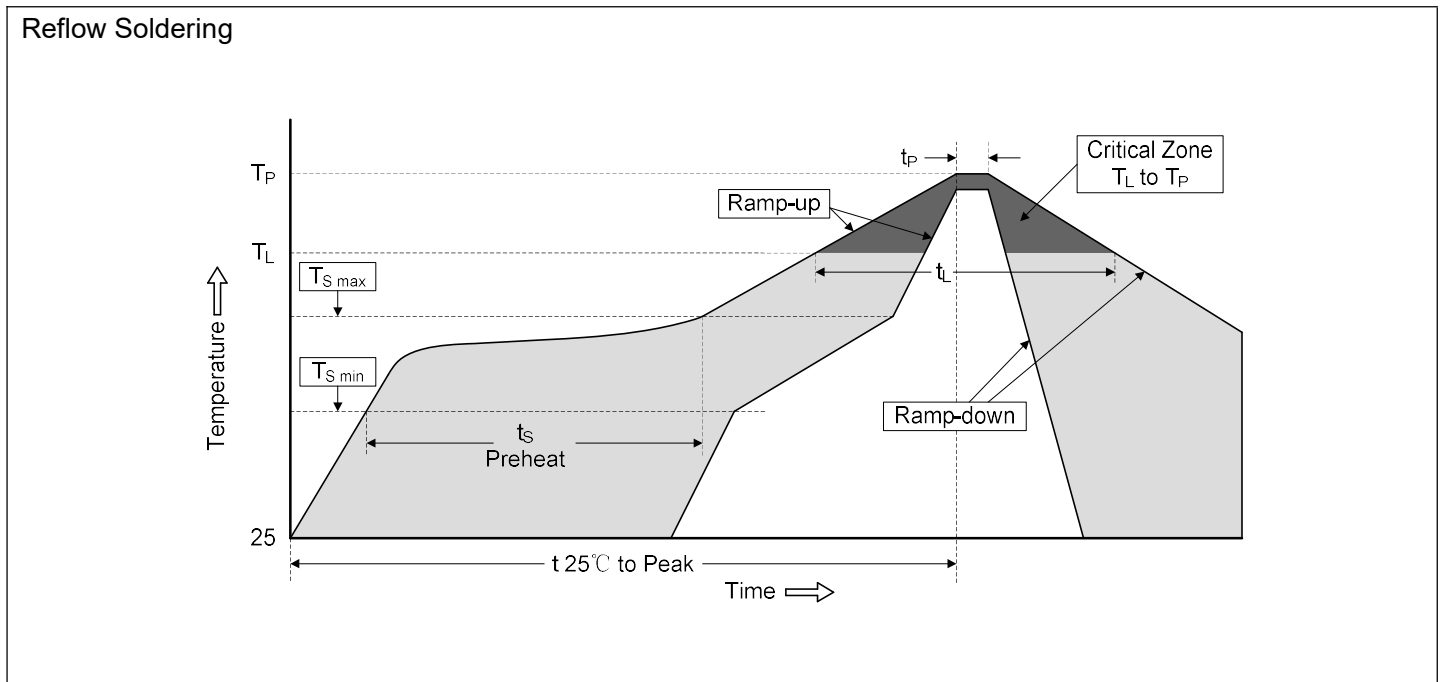

Figure 6. Maximum Non-Repetitive Forward Surge Current Uni-Directional Only



Soldering Parameters



Profile Feature	Pb-Free Assembly
Average ramp-up rate (T_L to T_P)	3°C/second max.
Preheat -Temperature Min ($T_{S\ min}$) -Temperature Max ($T_{S\ max}$) -Time (min to max) (t_s)	150°C 200°C 60-180 seconds
$T_{S\ max}$ to T_L -Ramp-up Rate	3°C/second max.
Time maintained above: -Temperature (T_L) -Time (t_L)	217°C 60-150 seconds
Peak Temperature (T_P)	260°C
Time within 5°C of actual Peak Temperature (t_p)	20-40 seconds
Ramp-down Rate	6°C/second max.
Time 25°C to Peak Temperature	8 minutes max.

Part Number Code and Marking Code

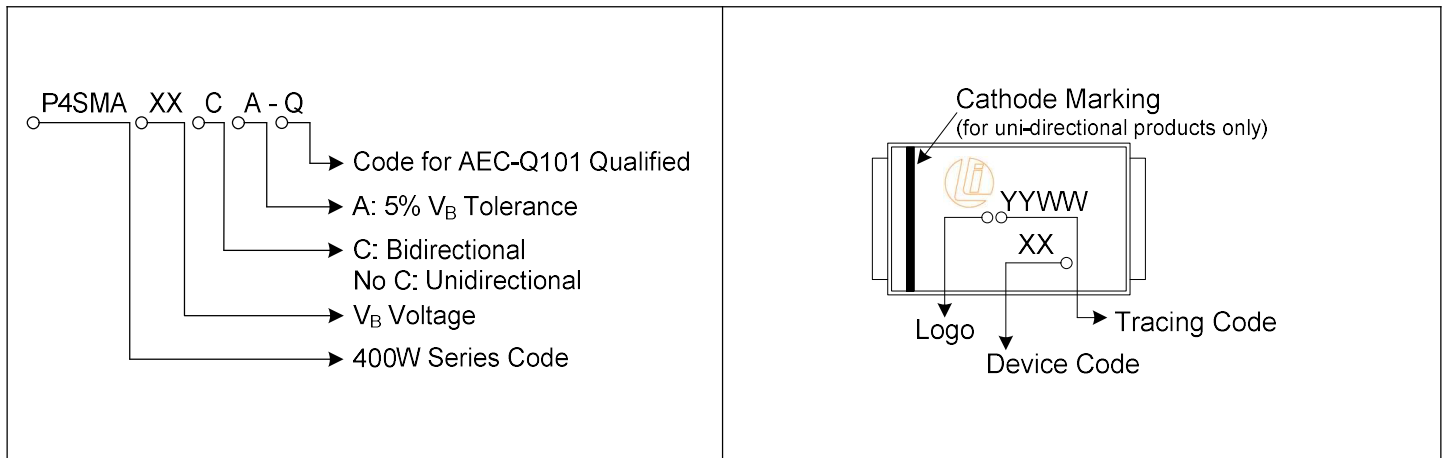

Dimensions (SMA/DO-214AC)

Symbol	Millimeters		Inches	
	Min.	Max.	Min.	Max.
A	1.250	1.650	0.049	0.065
B	3.990	4.600	0.157	0.181
C	2.400	2.790	0.095	0.110
D	1.900	2.290	0.075	0.090
E	0.780	1.520	0.030	0.060
F	-	0.203	-	0.008
G	4.800	5.280	0.189	0.208
H	0.152	0.305	0.006	0.012
I	1.800	-	0.070	-
J	2.100	-	0.082	-
K	-	2.300	-	0.090

Packaging Specification

Tape

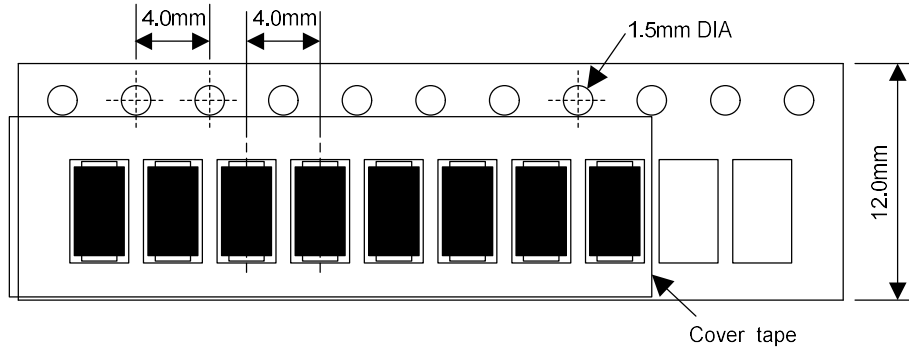

For Uni-Devices

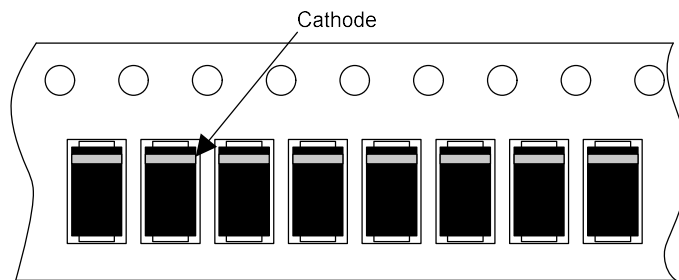

13 Inches Reel

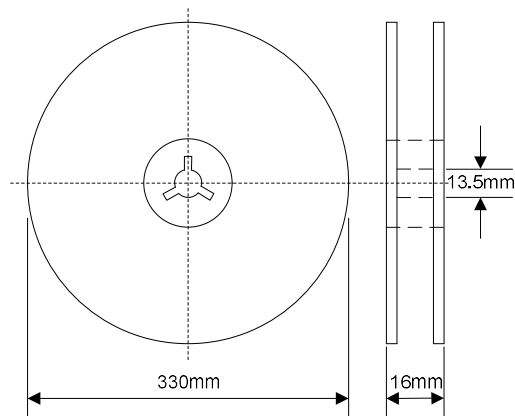

Quantity: 5000pcs/reel